

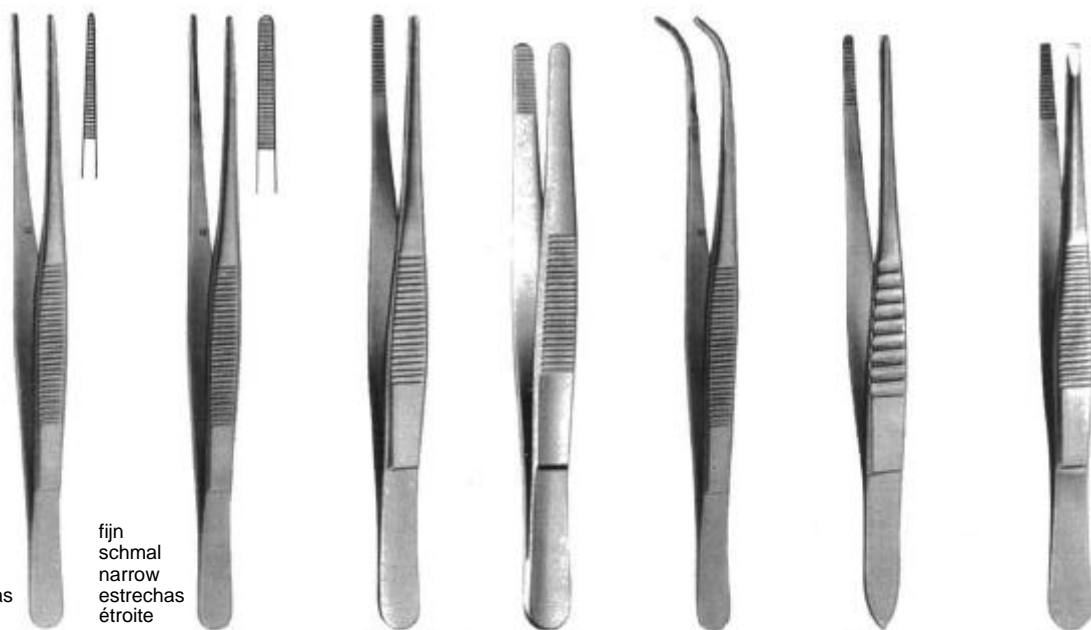

| cm | in. |           |           |           | MICRO-ADSON | ADSON     | ADSON     | SEMKEN    | Mc INDOE  |
|----|-----|-----------|-----------|-----------|-------------|-----------|-----------|-----------|-----------|
| 10 | 4   | 220.00100 | 220.00200 | 220.00300 |             |           |           |           |           |
| 12 | 4¾  |           |           |           | 220.00400   | 220.00600 | 220.00800 | 220.00900 |           |
| 15 | 6   |           |           |           | 220.00500   | 220.00700 |           | 220.01000 | 220.01100 |



zeer fijn  
 extra schmal  
 extra narrow  
 muy estrechas  
 très étroite

fijn  
 schmal  
 narrow  
 estrechas  
 étroite

| cm   | in. |           |           | STANDARD  |           | USA       | STILLE    |           |
|------|-----|-----------|-----------|-----------|-----------|-----------|-----------|-----------|
| 10,5 | 4¼  |           |           | 220.02400 |           |           |           |           |
| 11,5 | 4½  |           | 220.01500 | 220.02500 |           | 220.03500 | 220.04400 | 220.05200 |
| 13   | 5   | 220.01200 | 220.01600 | 220.02600 |           | 220.03600 | 220.04500 | 220.05300 |
| 14   | 5½  | 220.01300 | 220.01700 | 220.02700 | 220.03400 | 220.03700 | 220.04600 |           |
| 15   | 6   |           | 220.01800 | 220.02800 |           | 220.03800 | 220.04700 | 220.05400 |
| 16   | 6¼  | 220.01400 | 220.01900 | 220.02900 |           | 220.03900 |           |           |
| 17   | 6¾  |           |           |           |           |           |           | 220.05500 |
| 18   | 7   |           | 220.02000 | 220.03000 |           | 220.04000 | 220.04800 |           |
| 20   | 8   |           | 220.02100 | 220.03100 |           | 220.04100 | 220.04900 | 220.05600 |
| 25   | 10  |           | 220.02200 | 220.03200 |           | 220.04200 | 220.05000 | 220.05700 |
| 30   | 12  |           | 220.02300 | 220.03300 |           | 220.04300 | 220.05100 |           |



| cm | in. | WAUGH     | BROPHY    | BROPHY    | DUEHRSEN  |           |           |           |
|----|-----|-----------|-----------|-----------|-----------|-----------|-----------|-----------|
| 18 | 7   | 220.12900 |           |           |           | 220.13400 |           |           |
| 20 | 8   | 220.13000 | 220.13100 | 220.13200 | 220.13300 | 220.13500 | 220.13600 | 220.13700 |

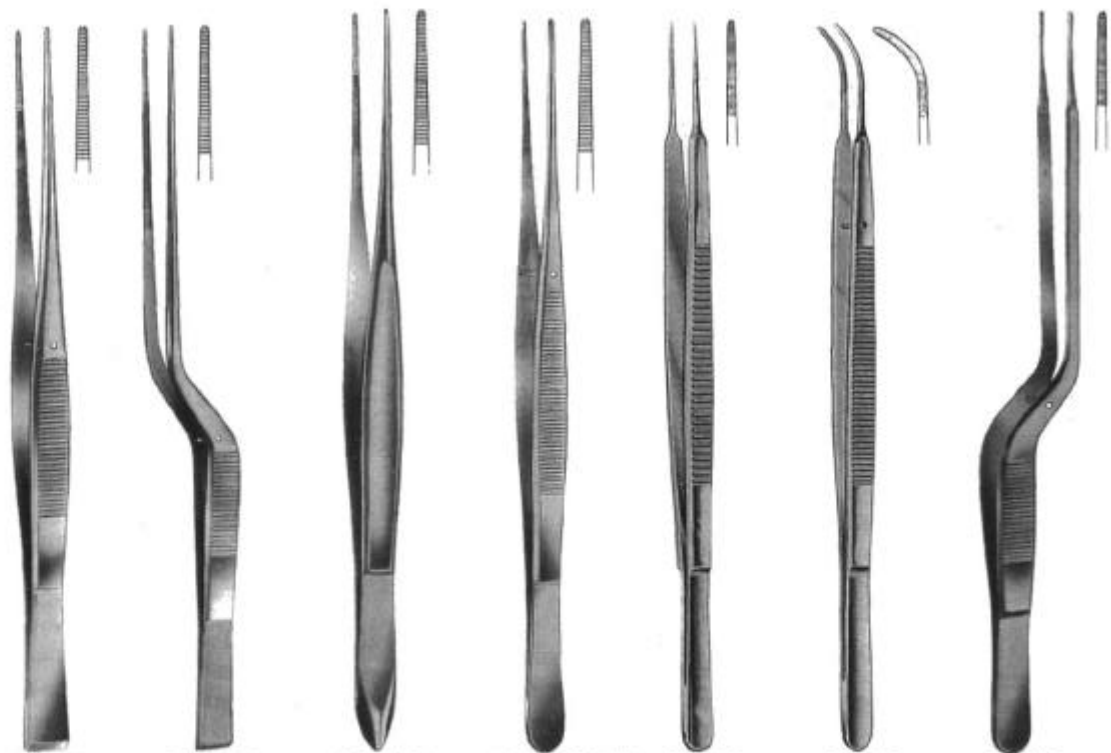

| cm | in.    | TAYLOR    | TAYLOR    | CUSHING   | POTTS-SMITH | GERALD    | GERALD    | GERALD    |
|----|--------|-----------|-----------|-----------|-------------|-----------|-----------|-----------|
| 18 | 7      | 220.13800 | 220.14000 | 220.14200 | 220.14300   | 220.14800 | 220.14900 | 220.15000 |
| 20 | 8      | 220.13900 | 220.14100 |           |             |           |           |           |
| 21 | 8 1/4  |           |           |           | 220.14400   |           |           |           |
| 24 | 9 1/4  |           |           |           | 220.14500   |           |           |           |
| 26 | 10 1/4 |           |           |           | 220.14600   |           |           |           |
| 30 | 12     |           |           |           | 220.14700   |           |           |           |

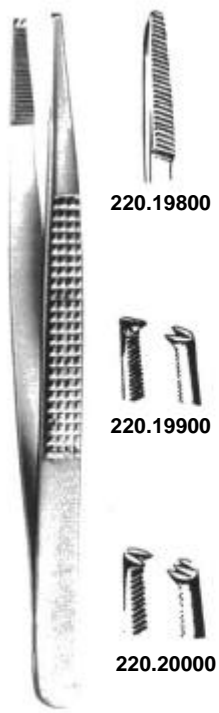

**BONNEY**  
20 cm, 8"

220.19800

220.19900

220.20000



**ADSON**  
18 cm, 7"

220.20100

220.20200  
1 x 2

220.20300  
2 x 3

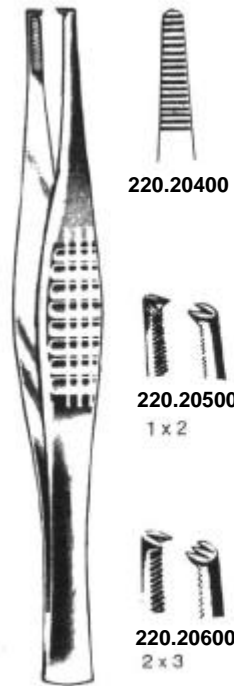

**RAMSAY-FERRIS SMITH**  
17 cm, 6 3/8"

220.20400

220.20500  
1 x 2

220.20600  
2 x 3



**TREVES**  
220.20700 13 cm, 5"  
220.20800 15 cm, 6"



**JEAN**  
220.20900 14 cm, 5 1/2"  
220.21000 18 cm, 7"



220.21100 12,5 cm, 5"  
220.21200 15 cm, 6"  
220.21300 18 cm, 7"  
220.21400 20 cm, 8"



220.21500 12,5 cm, 5"  
220.21600 15 cm, 6"  
220.21700 18 cm, 7"  
220.21800 20 cm, 8"



**COLLIN-DUVAL**  
220.21900 14 cm, 5 1/2"  
220.22000 20 cm, 8"  
220.22100 20 cm, 8"  
220.22200 20 cm, 8"

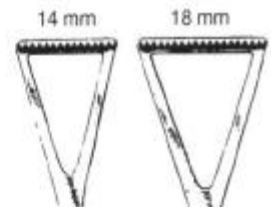

220.21900 14 mm  
220.22100 18 mm



220.22200 27 mm

PINCETTES  
 PINZETTES  
 FORCEPS  
 PINZAS  
 PINCETTES

**Lubberts®**



**CRAFOORD**  
 220.22300  
 24 cm, 9½"



**SINGLEY-TUTTLE**  
 220.22400 18 cm, 7"  
 220.22500 23 cm, 9"



**220.22600**  
 22 cm, 8⅔"



**220.22700**  
 22 cm, 8⅔"



**DAVIS**  
 220.22800  
 25 cm, 10"



**RUSSISCH MODEL**  
 220.22900 15 cm, 6"  
 220.23000 20 cm, 8"  
 220.23100 25 cm, 10"



**DURANTE**  
 220.23200 14,5 cm, 5½"  
 220.23300 16 cm, 6¼"  
 220.23400 20 cm, 8"



**MAYO**  
 220.23500 23 cm, 9"



**WANGENSTEEN**  
 220.23600 15 cm, 6"  
 220.23700 23 cm, 9"

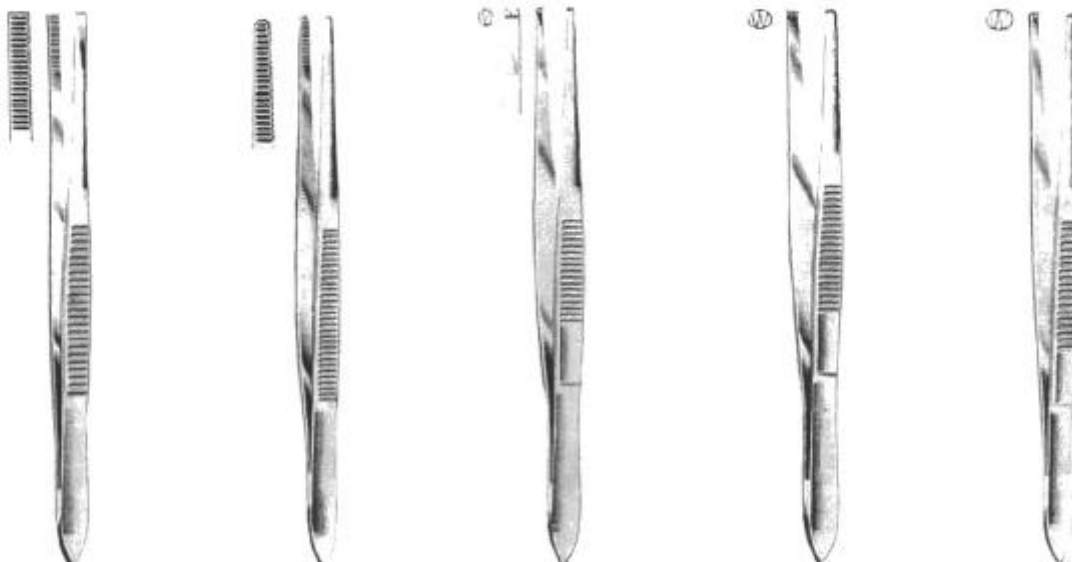

| cm | In.   |           |           |           |           |           |
|----|-------|-----------|-----------|-----------|-----------|-----------|
| 13 | 5 1/8 | 220.31800 | 220.32000 | 220.32400 | 220.32800 | 220.33200 |
| 15 | 6     | 220.31900 | 220.32100 | 220.32500 | 220.32900 | 220.33300 |
| 17 | 6 3/4 | 220.05500 | 220.32200 | 220.32600 | 220.33000 | 220.33400 |
| 20 | 8     | 220.05600 | 220.32300 | 220.32700 | 220.33100 | 220.33500 |

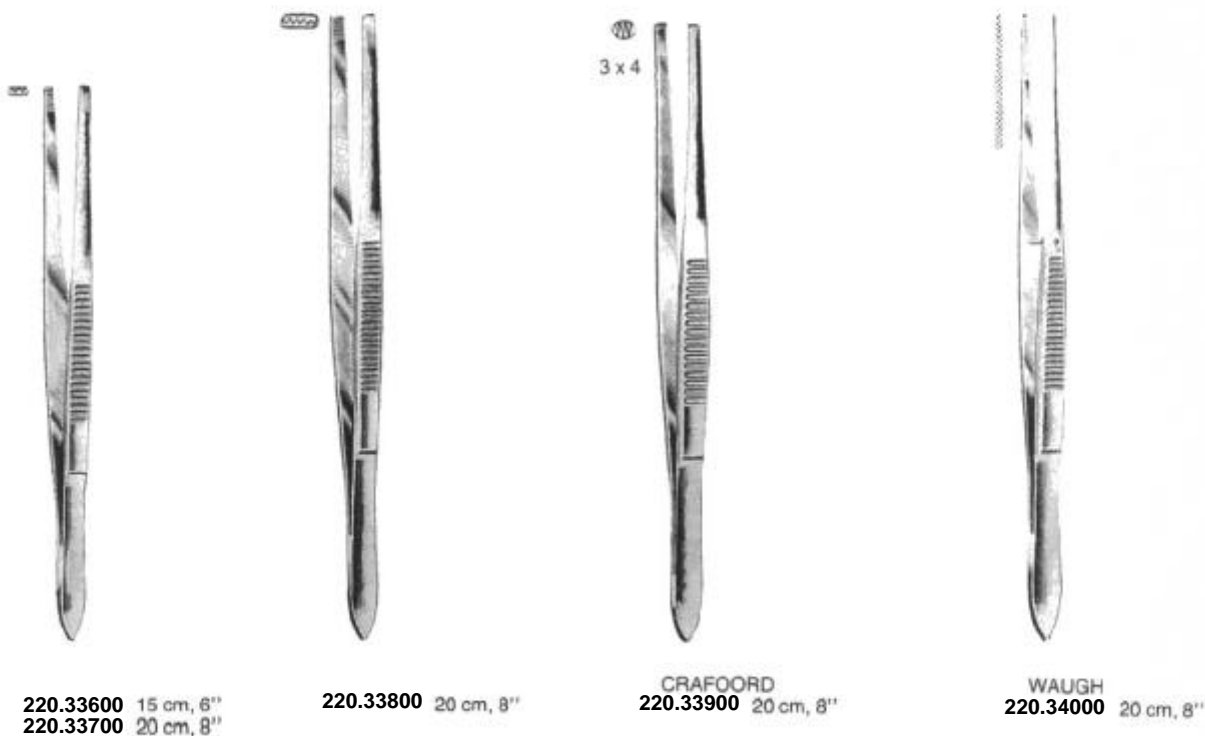



**MICRO-ADSON**  
 225.03700 14 cm, 5½"



225.03700



225.03800



**GEMINI**  
 225.03900  
 14 cm, 5½"

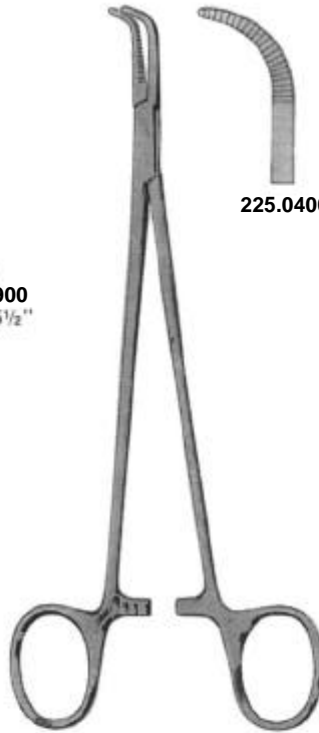

**BABY-MIXTER**  
 225.04000 18 cm, 7"



225.04000



**MEEKER**  
 225.04100 18 cm, 7"



225.04100



**GEMINI**  
 225.04200  
 18,5 cm, 7¼"



**MIXTER**  
 225.04300 20 cm, 8"



**OVERHOLT-MIXTER**  
 225.04400 21 cm, 8¼"



**MIXTER**  
 225.04500 23 cm, 9"



ARTERIE-, PREPAREER- EN LIGATUURKLEMMEN  
 ARTERIENKLEMMEN, PRÄPARIER- UND LIGATURKLEMMEN  
 ARTERY FORCEPS, DISSECTING AND LIGATURE FORCEPS  
 PINZAS HEMOSTATICAS, PINZAS PARA PREPARACIONES Y LIGADURAS  
 PINCES HEMOSTATIQUES, PINCES A DISSECTION ET A LIGATURES



RUMEL  
23 cm, 9"



225.29200



225.29300



225.29400



225.29500



225.29600

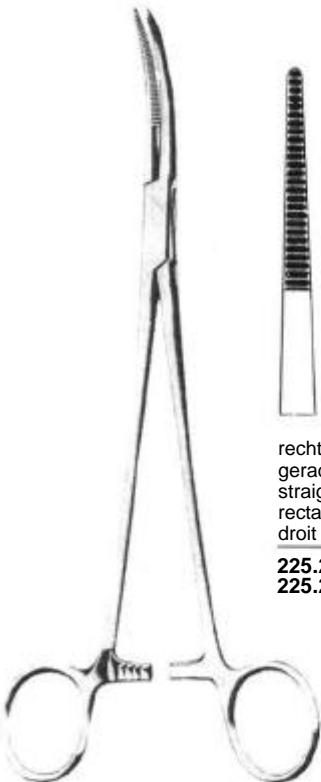

TOENNIS



recht  
gerade  
straight  
recta  
droit

225.29700  
225.29800



gebogen  
gebogen  
curved  
curva  
courbe

225.29900  
225.30000

| cm | in.     |
|----|---------|
| 21 | 8 1/4"  |
| 26 | 10 1/4" |



recht  
gerade  
straight  
recta  
droit

225.30100  
225.30200



gebogen  
gebogen  
curved  
curva  
courbe

225.30300  
225.30400

1 x 2 tands  
1 x 2 Zähne  
1 x 2 teeth  
1 x 2 dientes  
1 x 2 dents



TOENNIS



MIXTER



|                  |                  |                  |                  |
|------------------|------------------|------------------|------------------|
| MICRO-ADSON      |                  |                  | BABY-MIXTER      |
| <b>225.03700</b> | <b>225.32800</b> | <b>225.32900</b> | <b>225.04000</b> |
| 14 cm, 5½"       | 14 cm, 5½"       | 16 cm, 6¼"       | 18 cm, 7"        |



DEBAKEY-MIXTER

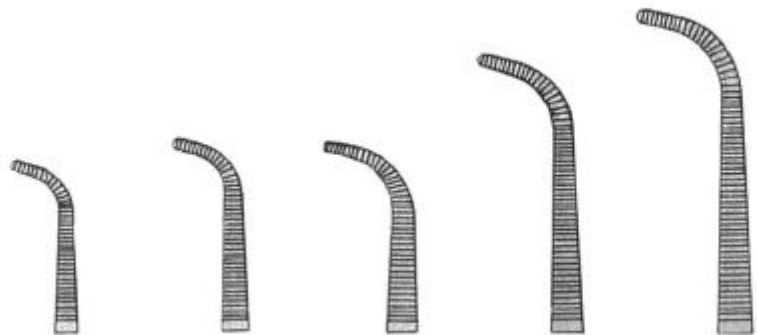

|                  |                  |                  |                  |                  |
|------------------|------------------|------------------|------------------|------------------|
| <b>225.33100</b> | <b>225.33200</b> | <b>225.33300</b> | <b>225.33400</b> | <b>225.33500</b> |
| 13 cm, 5"        | 16 cm, 6¼"       | 18 cm, 7"        | 20 cm, 8"        | 23 cm, 9"        |

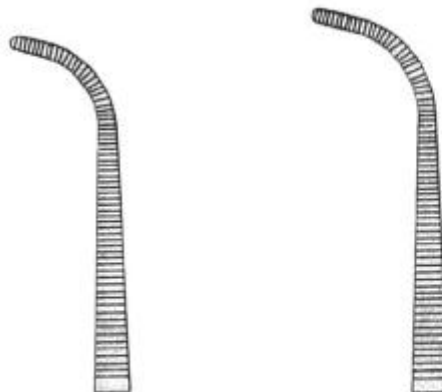

|                  |                  |
|------------------|------------------|
| <b>225.33600</b> | <b>225.33700</b> |
| 25 cm, 10"       | 28 cm, 11"       |

PREPAREERKLEMMEN  
 PRÄPARIERKLEMMEN  
 DISSECTING FORCEPS  
 PINZAS PARA PREPARACIONES  
 PINCES A DISSECTION

**Lubberts®**



BABY-MIXTER  
 225.03800 14 cm, 5½"



MEEKER  
 225.04100 18 cm, 7"



KANTROWITZ  
 225.34000 16 cm, 6¼"  
 225.34100 18,5 cm, 7¼"



MIXTER-PAUL  
 225.34200 20 cm, 8"



KANTROWITZ  
 225.34300 23 cm, 9"



WIKSTROEM  
 225.34400 21 cm, 8¼"  
 225.34500 24 cm, 9½"



LAHEY



**225.34600**  
 19 cm, 7½"  
 fijn  
 delikat  
 delicate  
 delicada  
 délicat



**225.34700**  
 19 cm, 7½"



**225.34800**  
 23 cm, 9"



**225.34900**  
 23 cm, 9"  
 fijn  
 delikat  
 delicate  
 delicada  
 délicat

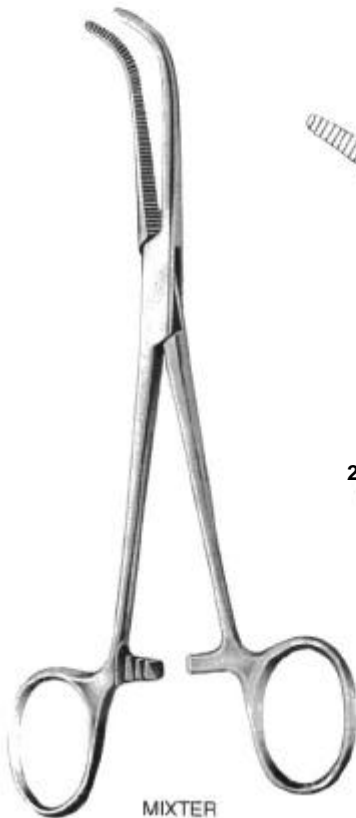

MIXTER

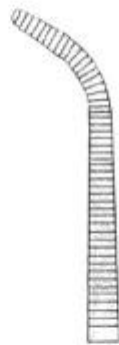

**225.35000**  
 16 cm, 6"

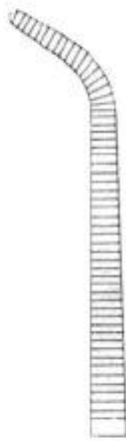

**225.35100**

19,5 cm, 7¾"  
**225.35200**  
 22 cm, 8¾"



**225.35300**  
 22 cm, 8¾"



O'SHAUGHNESSY  
**225.35400** 19 cm, 7½"

GALKANAAL-KLEMMEN  
 GALLENKANALKLEMZANGEN  
 GALL DUCT FORCEPS  
 PINZAS CLAMPS PARA CONDUCTO BILIARES  
 PINCES DE SERRAGE POUR LE CANAL BILIAIRE

**Lubberts®**



MOYNIHAN  
 260.05600 22 cm, 8<sup>3</sup>/<sub>4</sub>"  
 260.05700 30 cm, 12"



LAHEY  
 225.34700 19 cm, 7<sup>1</sup>/<sub>2</sub>"  
 225.34600 19 cm, 7<sup>1</sup>/<sub>2</sub>"

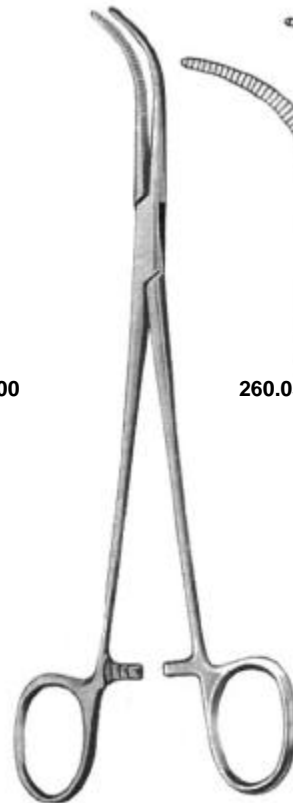

GREEN  
 260.05800 20 cm, 8"  
 260.05900 23 cm, 9"

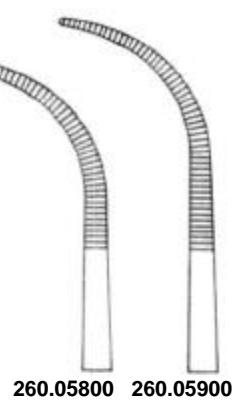

LOWER  
 260.06000 19 cm, 7<sup>1</sup>/<sub>2</sub>"



JOHN-HOPKINS  
 260.06100 20 cm, 8"



DESJARDINS  
 260.06200 20 cm, 8"

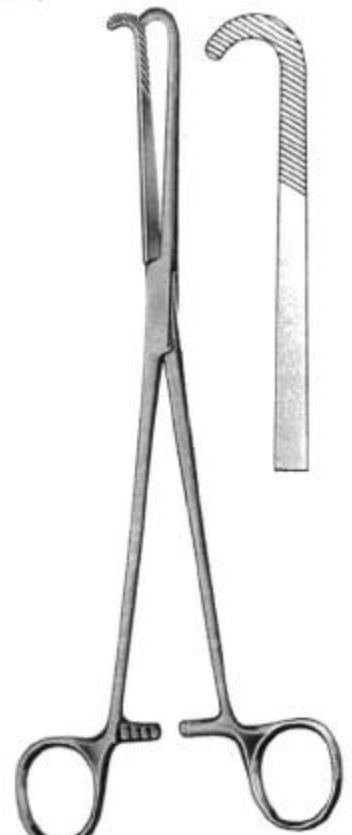

NISSEN  
 260.06300 23 cm, 9<sup>1</sup>/<sub>4</sub>"

DARMKLEMMEN  
 DARMFASSZANGEN  
 INTESTINAL GRASPING FORCEPS  
 PINZAS PARA COGER INTESTINOS  
 PINCES POUR PREHENSION DE L'INTESTIN

**Lubberts®**

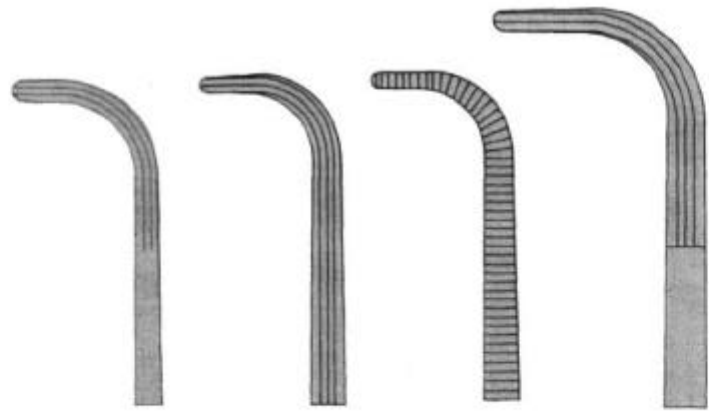

**225.35500**  
22 cm, 8<sup>3</sup>/<sub>4</sub>"

**225.35600**  
27,5 cm, 10<sup>3</sup>/<sub>4</sub>"

**225.35700**  
27,5 cm, 10<sup>3</sup>/<sub>4</sub>"

**225.35800**  
28 cm, 11"



**MIXTER**  
**225.35500** 22 cm, 8<sup>3</sup>/<sub>4</sub>"  
**225.35600** 27,5 cm, 10<sup>3</sup>/<sub>4</sub>"  
**225.35700** 27,5 cm, 10<sup>3</sup>/<sub>4</sub>"  
**225.35800** 28 cm, 11"



**ZENKER**  
**225.35900** 31 cm, 12<sup>1</sup>/<sub>4</sub>"  
**225.36000** 31 cm, 12<sup>1</sup>/<sub>4</sub>"

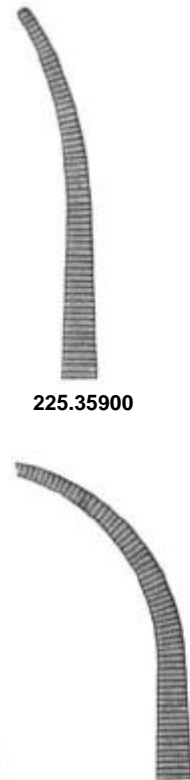

**225.35900**

**225.36000**



**MEEKER**  
**225.36100** 28 cm, 11"

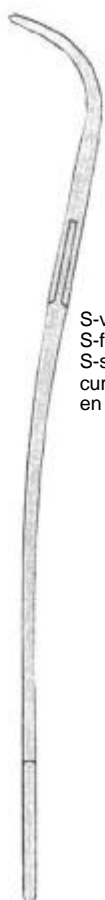

S-vormig gebogen  
 S-formig gebogen  
 S-shaped  
 curvas en S  
 en courbe de S



DUESSELDORF-HOSPITAL



**225.36200**  
 18,5 cm, 7½"



**225.36300**  
 20,5 cm, 8"

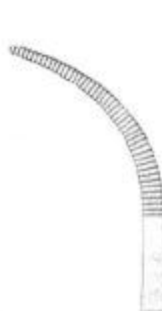

**225.36400**  
 21 cm, 8¼"



**225.36500**  
 21,5 cm, 8½"



OVERHOLT-GEISSENDOERFER



**225.36600**  
 19 cm, 7½"



**225.36700**  
 19 cm, 7½"



**225.36800**  
 20,5 cm, 8"



**225.36900**  
 21,5 cm, 8½"



**225.37000**  
 21 cm, 8¼"



**225.37100**  
 22,5 cm, 8¾"



**225.37200**  
 22,5 cm, 8¾"

**PREPAREER EN ARTERIEKLEMMEN**  
**PRÄPARIER- UND ARTERIENKLEMMEN**  
**DISSECTING AND HEMOSTATIC FORCEPS**  
**PINZAS PARA PREPARACIONES Y HEMOSTATICAS**  
**PINGES A DISSECTION ET HEMOSTATIQUES**

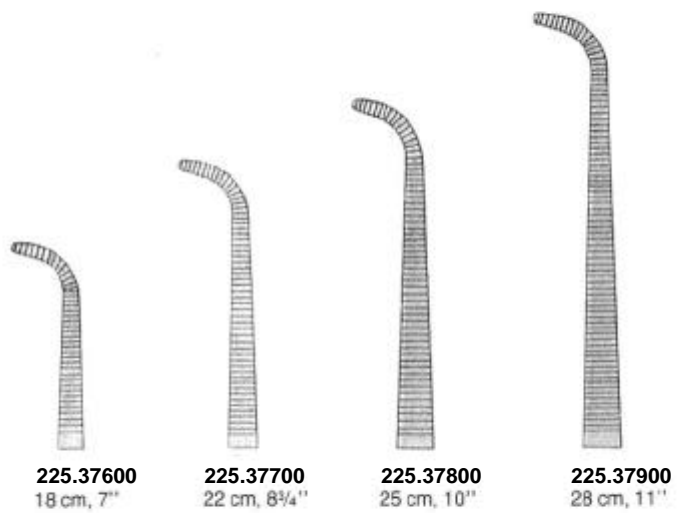

**TONSILLENZANGEN EN TONSILLENKLEMMEN**  
**TONSILLENZANGEN**  
**TONSIL SEIZING FORCEPS**  
**PINZAS PARA COGER LAS AMIGDALES**  
**PINCES POUR SAISIR LES AMYGDALES**

**Lubberts®**



**CORWIN**  
**345.06700**  
 14 cm, 5½"



**ROBERTS**  
**345.06800**  
 20 cm, 8"

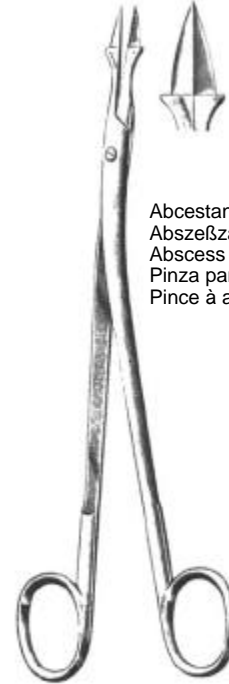

Abcestang  
 Abszeßzange  
 Abscess forceps  
 Pinza para absceso  
 Pince à abcès

**THILENIUS**  
**345.06900**  
 20 cm, 8"



**SCHNIDT**  
 19 cm, 7½"



225.37300    225.37400



**SCHNIDT**  
 19 cm, 7½"

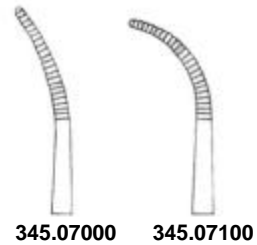

345.07000    345.07100